

IA Series Low Profile Antenna

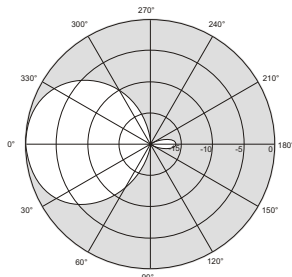

Vertical Pattern (Low Band)

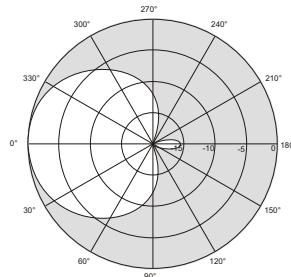

Horizontal Pattern (Low Band)

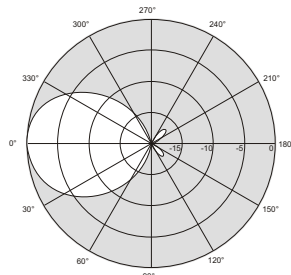

Vertical Pattern (High Band)

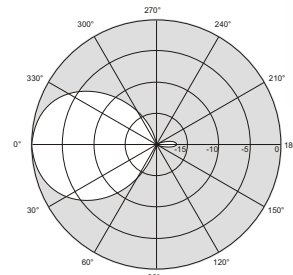

Horizontal Pattern (High Band)



| Specification | IA-103GDB | |
|------------------|-------------------------|-----------------|
| Frequency range | 824 ~ 960 MHz | 1710 ~ 2200 MHz |
| Gain | 6.5dBi | 7.5dBi |
| VSWR | ≤1.5 | ≤1.5 |
| Vert. Beam Width | 66° | 50° |
| Hori. Beam Width | 80° | 55° |
| Polarization | Vertical | |
| Max. Power | 25Watt | |
| Connector | N-F | |
| Impedence | 50 ohms | |
| Dimensions | Width 203mm Height 30mm | |
| Weight | 250g | |
| Radome Material | ASA Plastic | |

Eyecom company policy is one of continuing improvement, therefore we reserve the right to change this specification without notice.

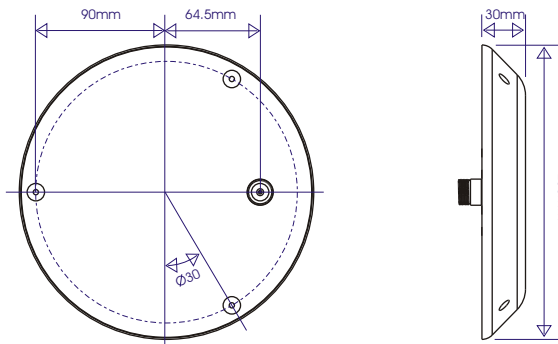

IA-103GDB

Horizon High pattern

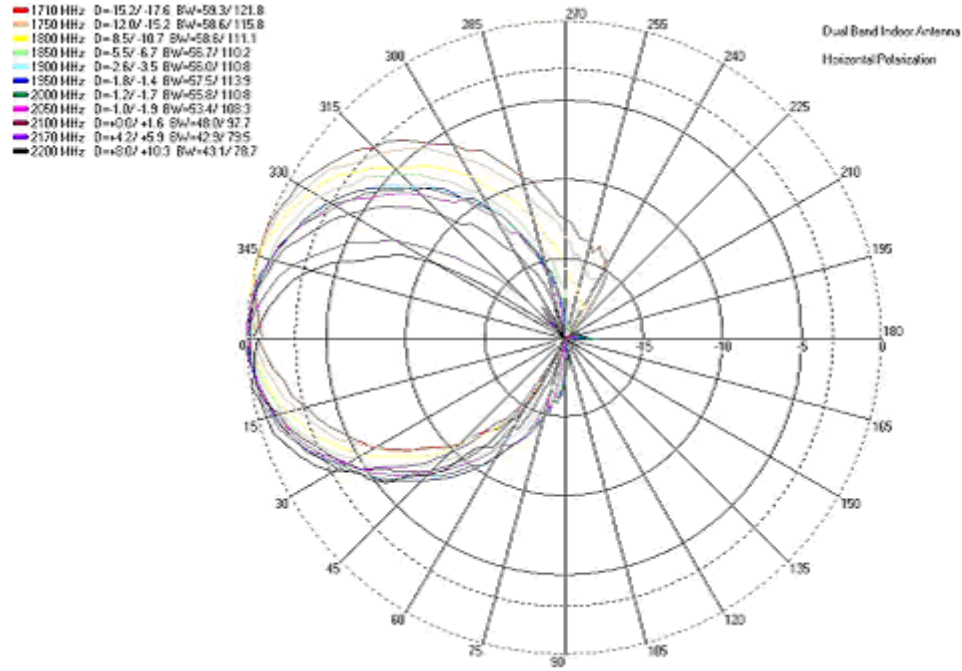

Horizon Low pattern

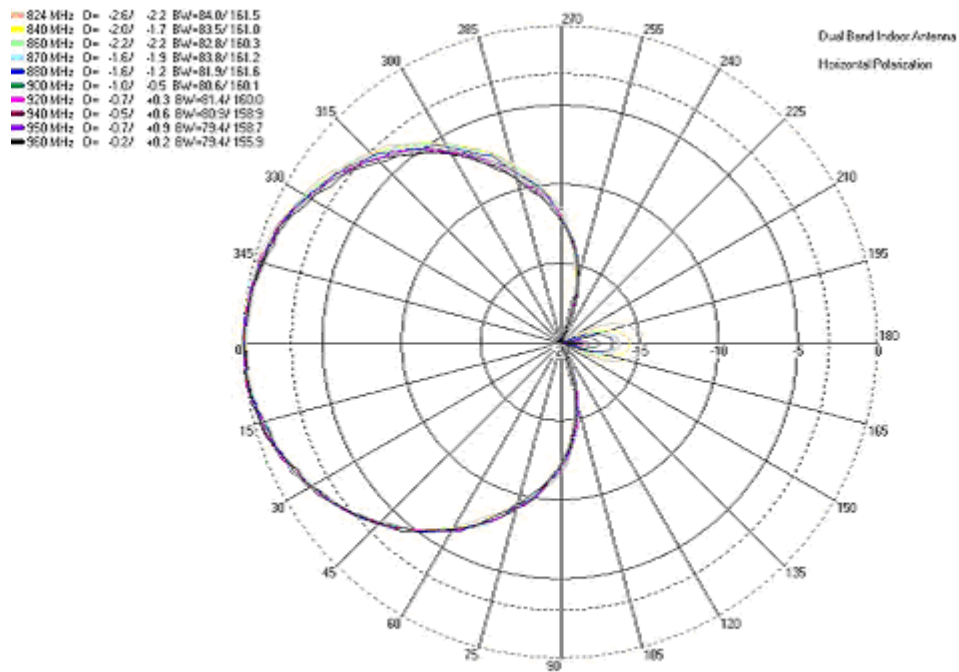

Vertical high pattern

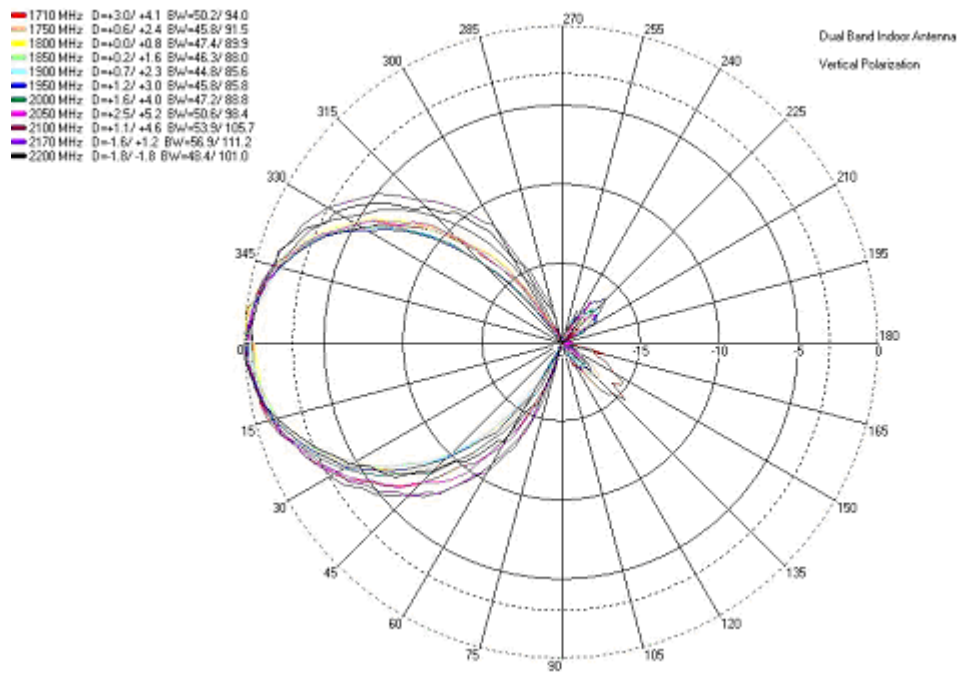

Vertical low pattern

